



Ventilation Equipment 430 S/S Wall Hood+Filters 1200X700mm

ITEM # _____

MODEL # _____

NAME # _____

SIS # _____

AIA # _____



642000 (MP712BT)

430 stainless steel Wall Hood with filters

Short Form Specification

Item No. _____

Constructed in 430 AISI stainless steel. Equipped with labyrinth filters in 430 AISI stainless steel, blind panels in 304 AISI stainless steel and condensate collecting tray.

Main Features

- External panels with upturned edges to avoid injuries.
- Prearranged for installation of lighting.
- Low noise level.

Construction

- Eyebolts and screw anchors for ceiling installation.
- 430 AISI stainless steel labyrinth filters easily removable for cleaning.
- Back drain pipe with drain hole to transfer grease into a 304 AISI container.
- 304 AISI stainless steel condensation collection tray.
- Labyrinth filters guarantee constant filtration to avoid clogging and to protect against fire.
- 304 AISI stainless steel blind panels for a correct exhaustion.
- Outlet holes are sized in order to minimize drops in pressure.
- Entirely constructed in 304 AISI stainless steel.

Optional Accessories

- Speed Variator for motors up to 1,17 kW PNC 640076
- Drain for hoods, diam.1/2" (m), PNC 640409 with plug

APPROVAL: _____



Experience the Excellence
www.electroluxprofessional.com

Front

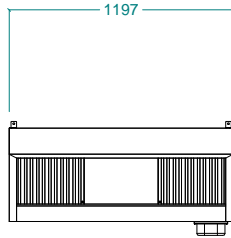

Side

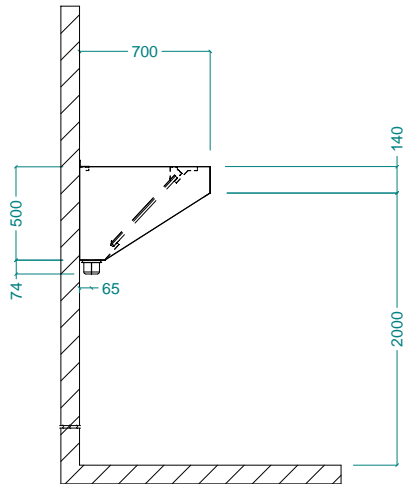

Top

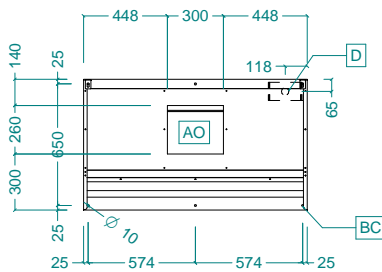
Key Information:

External dimensions, Width:	1200 mm
External dimensions, Depth:	700 mm
External dimensions, Height:	500 mm
Net weight:	20 kg

Air Emission:

Air capacity:	
642000 (MP712BT)	1000 mc/h